



# KETENCI®

SANAYİ VE TİCARET KOLL. ŞTİ.

*59. yıl*

## FİYAT LİSTESİ ŞUBAT 2026

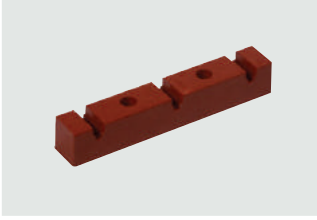
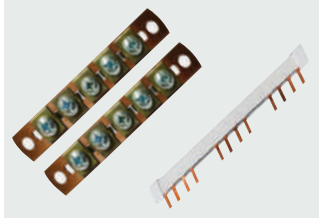
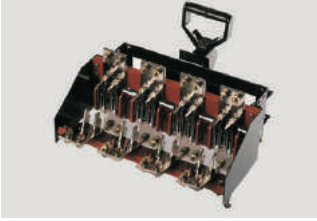
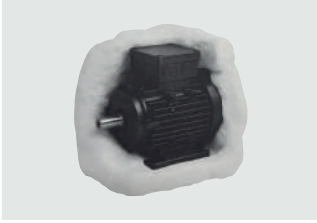



ENERJİYE YÖN VERİR



Ketenci San. Tic. ve Koll. Őti. 1967'de Sadettin Ketenci tarafından kurulmuŐtur. 1976'dan itibaren piyasadaki talepler dođrultusunda Őzengili Őalterler, İzalatörler ile Termo Plastik Kablo başlıkları ve Ek Mufları imal etmekte ve satıŐa sunmaktadır.

59 yıldır bu piyasada devamlılıđını sürdüren firmamız kendini sürekli yenileyerek ve Kalite Yönetim Sistemi hedefleri dođrultusunda geliŐtirerek müŐteri ihtiyacını ve memnuniyetini karŐılamaya çalıŐmaktadır.

## KETENCI ÖZENGİLİ ŞALTERLER



### ÖZENGİLİ ŞALTERLER (3 KONTAKLI)

KOD	TİP	ÜRÜN ADI	Derinlik	Yükseklik	Genişlik	Fiyat
01.101	KS. 101	200 Amper Özengili Şalter	180mm	140mm	134mm	6,000,00 TL.
01.102	KS. 102	250 Amper Özengili Şalter	240mm	190mm	205mm	7,000,00 TL.
01.103	KS. 103	400 Amper Özengili Şalter	280mm	253mm	230mm	10,500,00 TL.
01.104	KS. 104	630 Amper Özengili Şalter	280mm	253mm	230mm	14,500,00 TL.
01.105	KS. 105	1000 Amper Özengili Şalter	265mm	260mm	320mm	22,500,00 TL.
01.106	KS. 106	1500 Amper Özengili Şalter	270mm	270mm	384mm	31,000,00 TL.
01.107	KS. 107	2000 Amper Özengili Şalter	350mm	390mm	530mm	67,500,00 TL.
01.108	KS. 108	3000 Amper Özengili Şalter	350mm	390mm	530mm	95,000,00 TL.

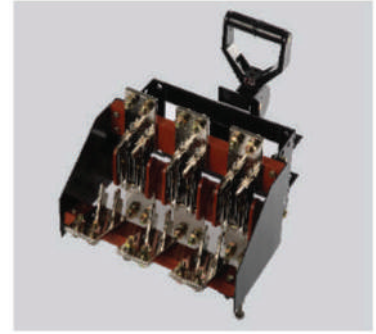

### ÖZENGİLİ ENVERSÖR ŞALTERLER (3 KONTAKLI)

KOD	TİP	ÜRÜN ADI	Derinlik	Yükseklik	Genişlik	Fiyat
02.111	KS.111	200 Amper Özengili Enversör Şalter	223mm	140mm	138mm	8,500,00 TL.
02.112	KS.112	250 Amper Özengili Enversör Şalter	315mm	190mm	210mm	10,500,00 TL.
02.113	KS.113	400 Amper Özengili Enversör Şalter	365mm	253mm	240mm	15,000,00 TL.
02.114	KS.114	630 Amper Özengili Enversör Şalter	365mm	253mm	240mm	20,000,00 TL.
02.115	KS.115	1000 Amper Özengili Enversör Şalter	360mm	260mm	334mm	31,500,00 TL.
02.116	KS.116	1500 Amper Özengili Enversör Şalter	360mm	260mm	394mm	42,500,00 TL.
02.117	KS.117	2000 Amper Özengili Enversör Şalter	490mm	390mm	540mm	92,500,00 TL.
02.118	KS.118	3000 Amper Özengili Enversör Şalter	490mm	390mm	540mm	135,000,00 TL.



### ÖZENGİLİ ŞALTERLER (4 KONTAKLI)

KOD	TİP	ÜRÜN ADI	Derinlik	Yükseklik	Genişlik	Fiyat
01.121	KS. 121	4X200 Amper Özengili Şalter	180mm	140mm	180mm	10,500,00 TL.
01.122	KS. 122	4X250 Amper Özengili Şalter	240mm	190mm	240mm	13,000,00 TL.
01.123	KS. 123	4X400 Amper Özengili Şalter	280mm	253mm	310mm	17,000,00 TL.
01.124	KS. 124	4X630 Amper Özengili Şalter	280mm	253mm	310mm	21,500,00 TL.
01.125	KS. 125	4X1000 Amper Özengili Şalter	265mm	260mm	420mm	37,500,00 TL.
01.126	KS. 126	4X1500 Amper Özengili Şalter	270mm	260mm	470mm	48,500,00 TL.

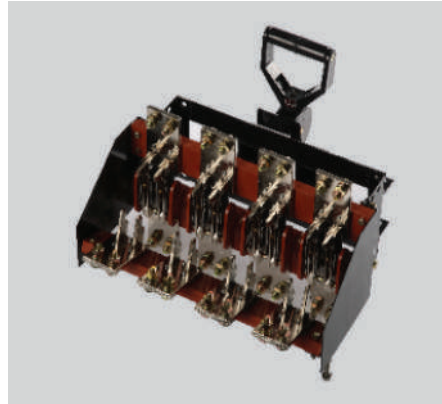

### ÖZENGİLİ ENVERSÖR ŞALTERLER (4 KONTAKLI)

KOD	TİP	ÜRÜN ADI	Derinlik	Yükseklik	Genişlik	Fiyat
02.131	KS.131	4X200 Amper Özengili Enversör Şalter	223mm	140mm	180mm	14,000,00 TL.
02.132	KS.132	4X250 Amper Özengili Enversör Şalter	315mm	190mm	240mm	17,500,00 TL.
02.133	KS.133	4X400 Amper Özengili Enversör Şalter	365mm	253mm	310mm	22,500,00 TL.
02.134	KS.134	4X630 Amper Özengili Enversör Şalter	365mm	253mm	310mm	31,000,00 TL.
02.135	KS.135	4X1000 Amper Özengili Enversör Şalter	360mm	260mm	420mm	50,000,00 TL.
02.136	KS.136	4X1500 Amper Özengili Enversör Şalter	360mm	260mm	470mm	61,500,00 TL.

# BARA MESNET İZOLATÖRLERİ

**BM 11**

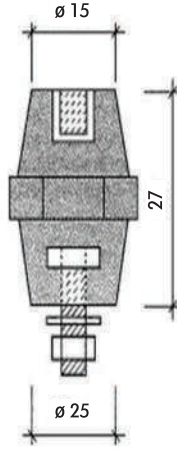
**BM 11/A**

## MİNİ İZOLATÖR

KOD	ÜRÜN ADI	KUTU AD.	KOLİ AD.	FİYAT
05.010	BM 11/A (M5 2C)	100	1500	26,50 TL.
05.009	BM 11 (M5 1C 1S)	100	1500	30,00 TL.
05.023	BM 10 (M5 2S)	100	1500	37,50 TL.

**BM 12**

**BM 14**

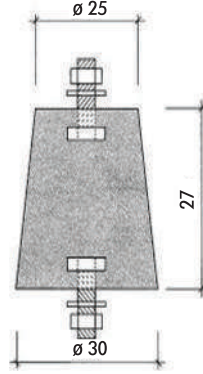
**BM 13**

## ORTA BOY İZOLATÖR

KOD	ÜRÜN ADI	KUTU AD.	KOLİ AD.	FİYAT
05.012	BM 14 (M6 2C)	100	500	33,00 TL.
05.018	BM 13 (M6 1C 1S)	100	500	36,00 TL.
05.011	BM 12 (M6 2S)	80	500	42,50 TL.

**BM 4**

**BM 5**

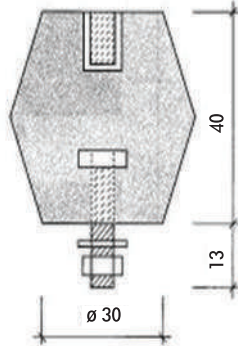
**BM 5/A**

## BÜYÜK BOY İZOLATÖR

KOD	ÜRÜN ADI	KUTU AD.	KOLİ AD.	FİYAT
05.003	BM 4 (M8 2C)	50	250	55,00 TL.
05.004	BM 5 (M8 1C 1S)	50	250	60,00 TL.
05.005	BM 5/A (M8 2S)	50	250	65,00 TL.

**BM 6/A**

**BM 7**

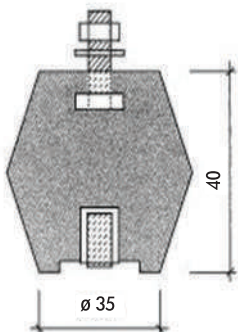
**BM 6**

## BÜYÜK BOY İZOLATÖR

KOD	ÜRÜN ADI	KUTU AD.	KOLİ AD.	FİYAT
05.007	BM 6/A (M10 2C)	40	200	77,50 TL.
05.008	BM 7 (M10 1C 1S)	40	200	80,00 TL.
05.006	BM 6 (M10 2S)	50	250	84,00 TL.

# BARA MESNET İZOLATÖRLERİ

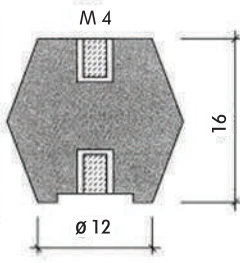
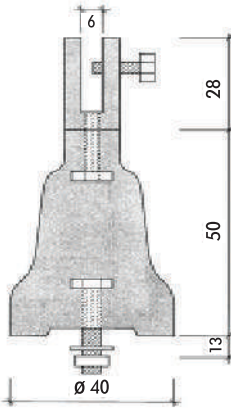
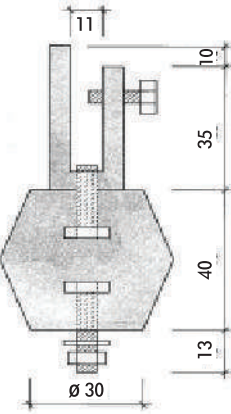
**BM 1**

**BM 2**

**BM 3**

**M 8**

**M 10**

## MİNİ İZOLATÖR

KOD	ÜRÜN ADI	KUTU AD.	KOLİ AD.	FİYAT
05.017	BM 1 (M4 2S)	250	1000	42,50 TL.

## PİRİNÇ SERFİLLİ İZOLATÖR

KOD	ÜRÜN ADI	KUTU AD.	KOLİ AD.	FİYAT
05.001	BM 2 (M8 PİRİNÇ SERFİLLİ)	50	300	250,00 TL.

## ÇELİK SERFİLLİ İZOLATÖR

KOD	ÜRÜN ADI	KUTU AD.	KOLİ AD.	FİYAT
05.002	BM 3 (M8 ÇELİK SERFİLLİ)	30	150	125,00 TL.

## SERFİLLER

KOD	ÜRÜN ADI	KUTU AD.	KOLİ AD.	FİYAT
05.020	M8 ÇELİK SERFİL	100	500	55,00 TL.
05.021	M10 ÇELİK SERFİL	100	500	55,00 TL.

## BARA MESNET İZOLATÖRLERİ

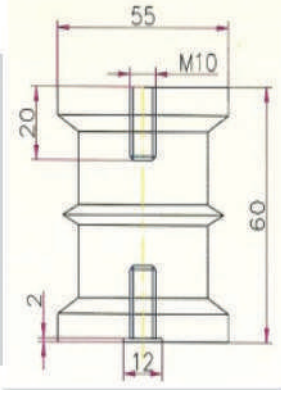

### 1N 500 İZOLATÖR

KOD	ÜRÜN ADI	KUTU AD.	FİYAT
05.016	1 N 500 (M 8 2S)	80	120,00 TL.
05.013	1 N 500 (M 10 2S)	80	140,00 TL.
05.014	1 N 500 (M 12 2S)	80	150,00 TL.

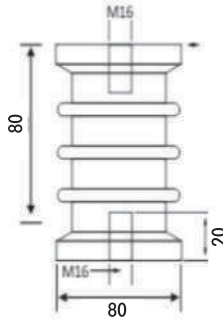

### 1N 1000 İZOLATÖR

KOD	ÜRÜN ADI	KUTU AD.	FİYAT
05.037	1 N 1000 (M 12 2S)	36	Fiyat sorunuz
05.038	1 N 1000 (M 16 2S)	36	Fiyat sorunuz

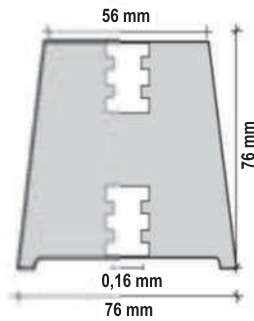

### 1NK İZOLATÖR

KOD	ÜRÜN ADI	KUTU AD.	FİYAT
05.015	1 NK (M 16 2S)	30	200,00 TL.

# TARAK İZOLATÖRLERİ



## 3 X 1F

KOD	ÜRÜN ADI	KUTU AD.	FİYAT
05.031	3 X 1F Tarak İzolatör	60	75,00 TL.

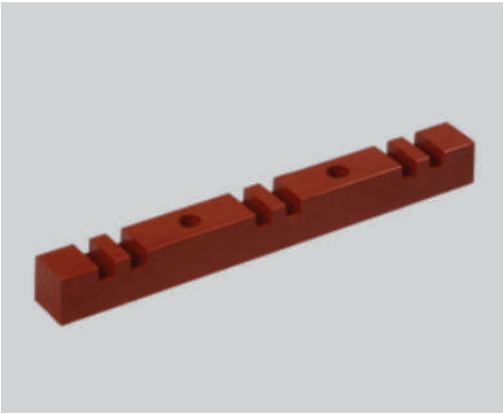
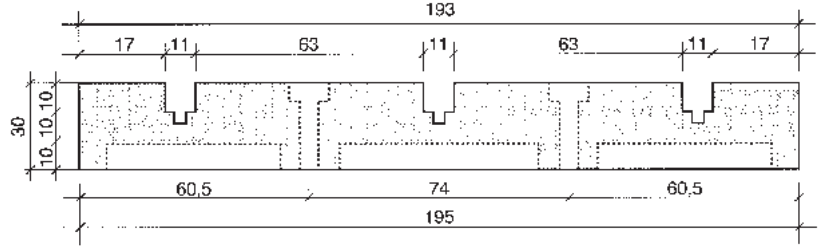

## 3 x 2F

KOD	ÜRÜN ADI	KUTU AD.	FİYAT
05.032	3 X 2F Tarak İzolatör	48	100,00 TL.

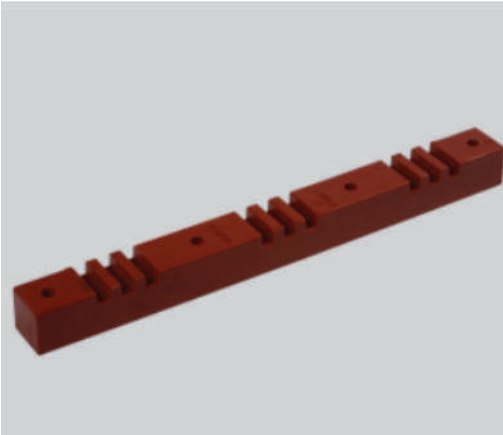
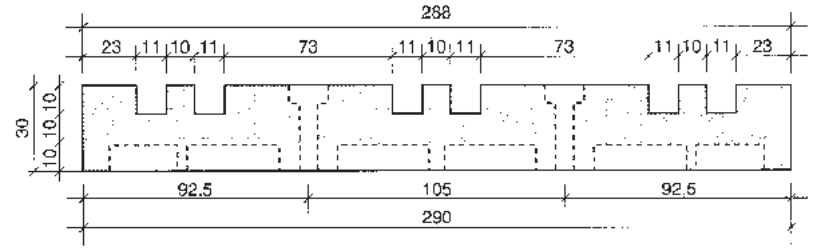

## 3 x 3F

KOD	ÜRÜN ADI	KUTU AD.	FİYAT
05.033	3 X 3F Tarak İzolatör	36	425,00 TL.

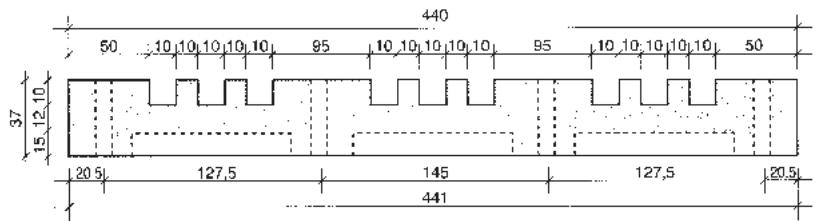

## TARAK İZOLATÖRLERİ



### 3 X 1F + N - (1 X 4F)

KOD	ÜRÜN ADI	KUTU AD.	FİYAT
05.034	3 X 1F+N Tarak İzolatör	30	105,00 TL.

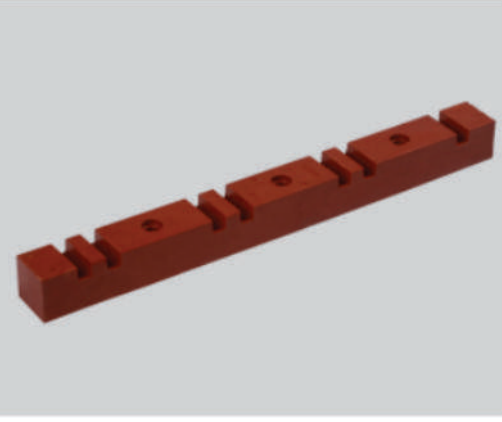
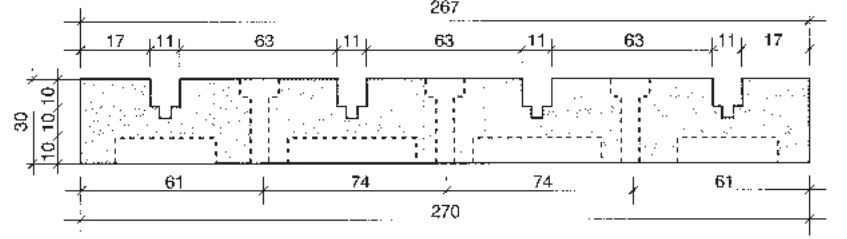

### 3 x 2F + N

KOD	ÜRÜN ADI	KUTU AD.	FİYAT
05.035	3 X 2F+N Tarak İzolatör	30	150,00 TL.

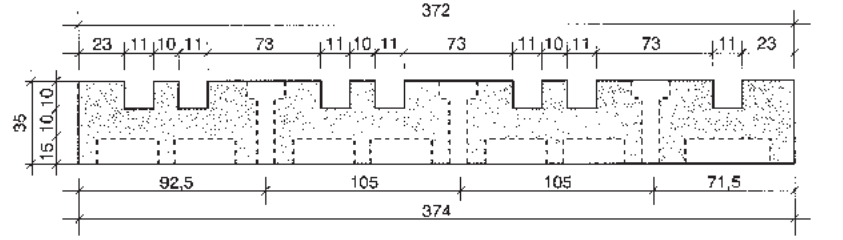

## TERMO PLASTİK REÇİNELİ EK MUFLARI 1kV



### REÇİNELİ EK MUFLAR 1kV STANDART BAKIR KABLolar İÇİN

KOD	TİP	KABLO KESİTİ	FİYAT
07.001	EM 1	4 x 2,5 mm <sup>2</sup>	625,00 TL.
07.002	EM 2	4 x 4 mm <sup>2</sup>	625,00 TL.
07.003	EM 3	4 x 6 mm <sup>2</sup>	625,00 TL.
07.004	EM 4	4 x 10 mm <sup>2</sup>	925,00 TL.
07.005/A	EM 5/A	4 x 16 mm <sup>2</sup>	950,00 TL.
07.005	EM 5	3 x16 +10 mm <sup>2</sup>	950,00 TL.
07.006	EM 6	3 x 25 +16 mm <sup>2</sup>	975,00 TL.
07.007	EM 7	3 x 35 +16 mm <sup>2</sup>	1,000,00 TL.
07.008	EM 8	3 x 50 +25 mm <sup>2</sup>	1,400,00 TL.
07.009	EM 9	3 x 70 +35 mm <sup>2</sup>	1,600,00 TL.
07.010	EM 10	3 x 95 +50 mm <sup>2</sup>	1,850,00 TL.
07.011	EM 11	3 x 120 +70 mm <sup>2</sup>	2,750,00 TL.
07.012	EM 12	3 x 150 +70 mm <sup>2</sup>	3,000,00 TL.
07.013	EM 13	3 x 185 +95 mm <sup>2</sup>	4,250,00 TL.
07.014	EM 14	3 x 240 +120 mm <sup>2</sup>	4,750,00 TL.

### REÇİNELİ EK MUFLAR 1kV ÇELİK ZIRHLI BAKIR KABLolar (NYFGbY) İÇİN

KOD	KABLO KESİTİ	FİYAT
09.001	4 x 10 mm <sup>2</sup>	950,00 TL.
09.002	4 x 16 mm <sup>2</sup>	950,00 TL.
09.002/A	3 x16 +10 mm <sup>2</sup>	950,00 TL.
09.003	3 x 25 +16 mm <sup>2</sup>	1,000,00 TL.
09.004	3 x 35 +16 mm <sup>2</sup>	1,000,00 TL.
09.005	3 x 50 +25 mm <sup>2</sup>	1,750,00 TL.
09.006	3 x 70 +35 mm <sup>2</sup>	1,900,00 TL.
09.007	3 x 95 +50 mm <sup>2</sup>	2,100,00 TL.
09.008	3 x 120 +70 mm <sup>2</sup>	3,250,00 TL.
09.009	3 x 150 +70 mm <sup>2</sup>	3,500,00 TL.
09.010	3 x 185 +95 mm <sup>2</sup>	4,850,00 TL.
09.011	3 x 240 +120 mm <sup>2</sup>	5,350,00 TL.

## TERMO PLASTİK REÇİNELİ EK MUFLARI 1kV



### KABLO BAŞLIKLARI 1kV

KOD	KABLO KESİTİ	FİYAT
06.001	No.1 4 x 10'dan - 4 x 2,5 mm <sup>2</sup>	425,00 TL.
06.002	No.2 4 x 35'den - 4 x 70 mm <sup>2</sup>	550,00 TL.
06.003	No.3 4 x 95'den - 4 x 150 mm <sup>2</sup>	750,00 TL.
06.004	No.4 4 x 185'den - 4 x 240 mm <sup>2</sup>	975,00 TL.

### EK MUFLARI 1 kV TEK DAMARLI BAKIR KABLolar İÇİN

KOD	KABLO KESİTİ	FİYAT
08.001	1 x 10 mm <sup>2</sup>	550,00 TL.
08.002	1 x 16 mm <sup>2</sup>	575,00 TL.
08.003	1 x 25 mm <sup>2</sup>	600,00 TL.
08.004	1 x 35 mm <sup>2</sup>	625,00 TL.
08.005	1 x 50 mm <sup>2</sup>	700,00 TL.
08.006	1 x 70 mm <sup>2</sup>	750,00 TL.
08.007	1 x 95 mm <sup>2</sup>	800,00 TL.
08.008	1 x 120 mm <sup>2</sup>	950,00 TL.
08.009	1 x 150 mm <sup>2</sup>	1,000,00 TL.
08.010	1 x 185 mm <sup>2</sup>	1,200,00 TL.
08.011	1 x 240 mm <sup>2</sup>	1,300,00 TL.

## TERMO PLASTİK REÇİNELİ EK MUFLARI 1kV



### REÇİNELİ EK MUFLAR 1 kV ALÜMİNYUM KABLolar İÇİN

KOD	KABLO KESİTİ	FİYAT
07.105	4 x 16 mm <sup>2</sup>	950,00 TL.
07.106	3 x 25 + 16 mm <sup>2</sup>	1,000,00 TL.
07.107	3 x 35 + 16 mm <sup>2</sup>	1,050,00 TL.
07.108	3 x 50 + 25 mm <sup>2</sup>	1,250,00 TL.
07.109	3 x 70 + 35 mm <sup>2</sup>	1,500,00 TL.
07.110	3 x 95 + 50 mm <sup>2</sup>	2,250,00 TL.
07.111	3 x 120 + 70 mm <sup>2</sup>	2,750,00 TL.
07.112	3 x 150 + 70 mm <sup>2</sup>	3,000,00 TL.
07.113	3 x 185 + 95 mm <sup>2</sup>	4,250,00 TL.
07.114	3 x 240 + 120 mm <sup>2</sup>	4,750,00 TL.

### EK MUFLAR 1 kV TEK DAMARLI ALÜMİNYUM KABLolar İÇİN

KOD	KABLO KESİTİ	FİYAT
08.102	1 x 16 mm <sup>2</sup>	575,00 TL.
08.103	1 x 25 mm <sup>2</sup>	600,00 TL.
08.104	1 x 35 mm <sup>2</sup>	625,00 TL.
08.105	1 x 50 mm <sup>2</sup>	700,00 TL.
08.106	1 x 70 mm <sup>2</sup>	750,00 TL.
08.107	1 x 95 mm <sup>2</sup>	800,00 TL.
08.108	1 x 120 mm <sup>2</sup>	950,00 TL.
08.109	1 x 150 mm <sup>2</sup>	1,000,00 TL.
08.110	1 x 185 mm <sup>2</sup>	1,250,00 TL.
08.112	1 x 240 mm <sup>2</sup>	1,300,00 TL.

## YENİDEN DOLDURULABİLİR EK MUFLARI



### DÜZ TİP GİRİŞ - ÇIKIŞ YENİDEN DOLDURULABİLİR EKMUF (BEDAŞ TİPİ)

ÜRÜN ADI	KABLO KESİTİ	SADECE KALIP (B)		KALIP İLAÇ (A)		KALIP İLAÇ MUF (C)	
		KOD	FİYAT	KOD	FİYAT	KOD	FİYAT
DM1 YEDO/ EK MUFU	4X2,5	15.101	1,000,00 TL.	15.001	1,625,00 TL.	15.201	1,875,00 TL.
DM1 YEDO/ EK MUFU	4X4	15.102	1,000,00 TL.	15.002	1,625,00 TL.	15.202	1,875,00 TL.
DM1 YEDO/ EK MUFU	4X6	15.103	1,000,00 TL.	15.003	1,625,00 TL.	15.203	1,875,00 TL.
DM2 YEDO/ EK MUFU	4X10	15.104	1,250,00 TL.	15.004	2,000,00 TL.	15.204	2,500,00 TL.
DM2/2 YEDO/ EK MUFU	4X16 (3X16+10)	15.108	1,350,00 TL.	15.008	2,250,00 TL.	15.208	2,650,00 TL.
DM2/2 YEDO/ EK MUFU	3X25+16	15.109	1,350,00 TL.	15.009	2,250,00 TL.	15.209	2,650,00 TL.
DM3 YEDO/ EK MUFU	3X35+16	15.110	1,500,00 TL.	15.010	2,250,00 TL.	15.210	2,650,00 TL.
DM3 YEDO/ EK MUFU	3X50+25	15.111	1,500,00 TL.	15.011	2,750,00 TL.	15.211	3,250,00 TL.
DM3 YEDO/ EK MUFU	3X70+35	15.112	1,500,00 TL.	15.012	2,750,00 TL.	15.212	3,250,00 TL.
DM4/1 YEDO/ EK MUFU	3X95+50	15.113	1,850,00 TL.	15.013	2,750,00 TL.	15.213	3,250,00 TL.
DM4/3 YEDO/ EK MUFU	3X120+70	15.117	2,250,00 TL.	15.017	5,000,00 TL.	15.217	5,875,00 TL.
DM4/3 YEDO/ EK MUFU	3X150+70	15.118	2,250,00 TL.	15.018	5,000,00 TL.	15.218	5,875,00 TL.
DM5 YEDO/ EK MUFU	3X185+95	15.119	2,400,00 TL.	15.019	5,500,00 TL.	15.219	6,500,00 TL.
DM5 YEDO/ EK MUFU	3X240+120	15.120	2,400,00 TL.	15.020	5,500,00 TL.	15.220	6,500,00 TL.

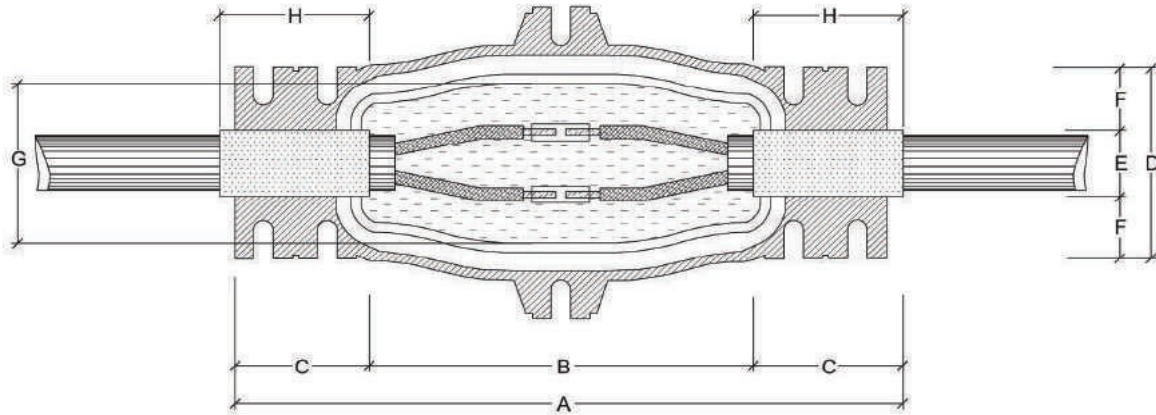

	KABLO mm <sup>2</sup>	A	B	C	D	E	F	G	BAND H	VIDA mm	YEDOFLEX
DM.1	2,5-4-6	204	120	42	58	22	18	50	50	6	300 gr
DM.2	10	264	180	42	67	31	18	60	50	6	600 gr
DM.2/2	10-16-25	310	206	52	67	31	18	90	60	6	1400 gr
DM.3	35-50-70	354	250	52	87	43	22	80	60	8	1400 gr
DM.4/3	95-120-150	550	410	70	99	55	22	125	80	8	4250 gr
DM.4	95	426	310	58	99	55	22	90	70	8	2250 gr
DM.5	185-240	496	380	58	114	70	22	100	70	8	4250 gr

## YENİDEN DOLDURULABİLİR EK MUFLARI



### Y TİPİ BRANŞMANLI YENİDEN DOLDURULABİLİR EKMUF (BEDAŞ TİPİ)

ÜRÜN ADI	KABLO KESİTİ	SADECE KALIP (B)		KALIP İLAÇ (A)		KALIP İLAÇ MUF (C)	
		KOD	FİYAT	KOD	FİYAT	KOD	FİYAT
YM1 YEDO/ EK MUFU	4X2,5	15.121	1,250,00 TL.	15.021	2,000,00 TL.	15.221	2,500,00 TL.
YM1 YEDO/ EK MUFU	4X4	15.122	1,250,00 TL.	15.022	2,000,00 TL.	15.222	2,500,00 TL.
YM1 YEDO/ EK MUFU	4X6	15.123	1,250,00 TL.	15.023	2,000,00 TL.	15.223	2,500,00 TL.
YM2 YEDO/ EK MUFU	4X10	15.124	1,500,00 TL.	15.024	2,750,00 TL.	15.224	3,250,00 TL.
YM2 YEDO/ EK MUFU	4X16 (3X16+10)	15.125	1,500,00 TL.	15.025	2,750,00 TL.	15.225	3,250,00 TL.
YM2 YEDO/ EK MUFU	3X25+16	15.126	1,500,00 TL.	15.026	2,750,00 TL.	15.226	3,250,00 TL.
YM3 YEDO/ EK MUFU	3X35+16	15.127	2,000,00 TL.	15.027	3,750,00 TL.	15.227	5,000,00 TL.
YM3 YEDO/ EK MUFU	3X50+25	15.128	2,000,00 TL.	15.028	3,750,00 TL.	15.228	5,000,00 TL.
YM3 YEDO/ EK MUFU	3X70+35	15.129	2,000,00 TL.	15.029	3,750,00 TL.	15.229	5,000,00 TL.
YM4/1 YEDO/ EK MUFU	3X95+50	15.130	2,500,00 TL.	15.030	5,500,00 TL.	15.230	7,250,00 TL.
YM4/1 YEDO/ EK MUFU	3X120+70	15.131	2,500,00 TL.	15.031	5,500,00 TL.	15.231	7,250,00 TL.
YM4/1 YEDO/ EK MUFU	3X150+70	15.132	2,500,00 TL.	15.032	5,500,00 TL.	15.232	7,250,00 TL.
YM5 YEDO/ EK MUFU	3X185+95	15.133	3,500,00 TL.	15.033	9,750,00 TL.	15.233	12,250,00 TL.
YM5 YEDO/ EK MUFU	3X240+120	15.134	3,500,00 TL.	15.034	9,750,00 TL.	15.234	12,250,00 TL.

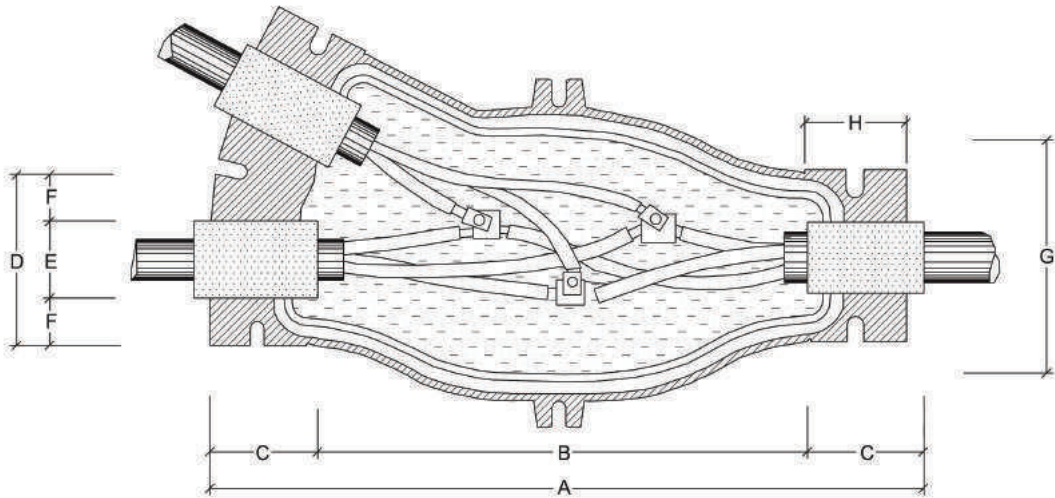

	KABLO mm <sup>2</sup>	A	B	C	D	E	F	G	BAND H	VIDA mm	YEDOFLEX
YM.1	2,5-4-6	244	160	42	58	22	18	70	50	6	600 gr
YM.2	10-16-25	324	240	42	67	31	18	100	50	6	1400 gr
YM.3	35-50-70	454	350	52	87	43	22	120	60	8	3500 gr
YM.4/1	95-120-150	490	400	45	97	55	22	150	70	8	5500 gr
YM.5	150-185-240	596	480	58	114	70	22	160	70	8	10500 gr

## YENİDEN DOLDURULABİLİR EK MUFLARI



### T TİP BRANŞMANLI YENİDEN DOLDURULABİLİR EKMUF (BEDAŞ TİPİ)

ÜRÜN ADI	KABLO KESİTİ	SADECE KALIP (B)		KALIP İLAÇ (A)		KALIP İLAÇ MUF (C)	
		KOD	FİYAT	KOD	FİYAT	KOD	FİYAT
TM 2 YEDO/ EK MUFU	4X10	15.135	1,625,00 TL.	15.035	3,000,00 TL.	15.235	3,500,00 TL.
TM 2 YEDO/ EK MUFU	4X16 (3X16+10)	15.136	1,625,00 TL.	15.036	3,000,00 TL.	15.236	3,500,00 TL.
TM 2 YEDO/ EK MUFU	3X25+16	15.137	1,625,00 TL.	15.037	3,000,00 TL.	15.237	3,500,00 TL.
TM 3 YEDO/ EK MUFU	3X35+16	15.138	2,250,00 TL.	15.038	4,250,00 TL.	15.238	5,250,00 TL.
TM 3 YEDO/ EK MUFU	3X50+25	15.139	2,250,00 TL.	15.039	4,250,00 TL.	15.239	5,250,00 TL.
TM 3 YEDO/ EK MUFU	3X70+35	15.140	2,250,00 TL.	15.040	4,250,00 TL.	15.240	5,250,00 TL.
TM 4 YEDO/ EK MUFU	3X95+50	15.141	2,750,00 TL.	15.041	6,500,00 TL.	15.241	8,250,00 TL.
TM 4 YEDO/ EK MUFU	3X120+70	15.142	2,750,00 TL.	15.042	6,500,00 TL.	15.242	8,250,00 TL.
TM 4 YEDO/ EK MUFU	3X150+70	15.143	2,750,00 TL.	15.043	6,500,00 TL.	15.243	8,250,00 TL.
TM 5 YEDO/ EK MUFU	3X185+95	15.144	4,250,00 TL.	15.044	12,000,00 TL.	15.244	15,000,00 TL.
TM 5 YEDO/ EK MUFU	3X240+120	15.145	4,250,00 TL.	15.045	12,000,00 TL.	15.245	15,000,00 TL.

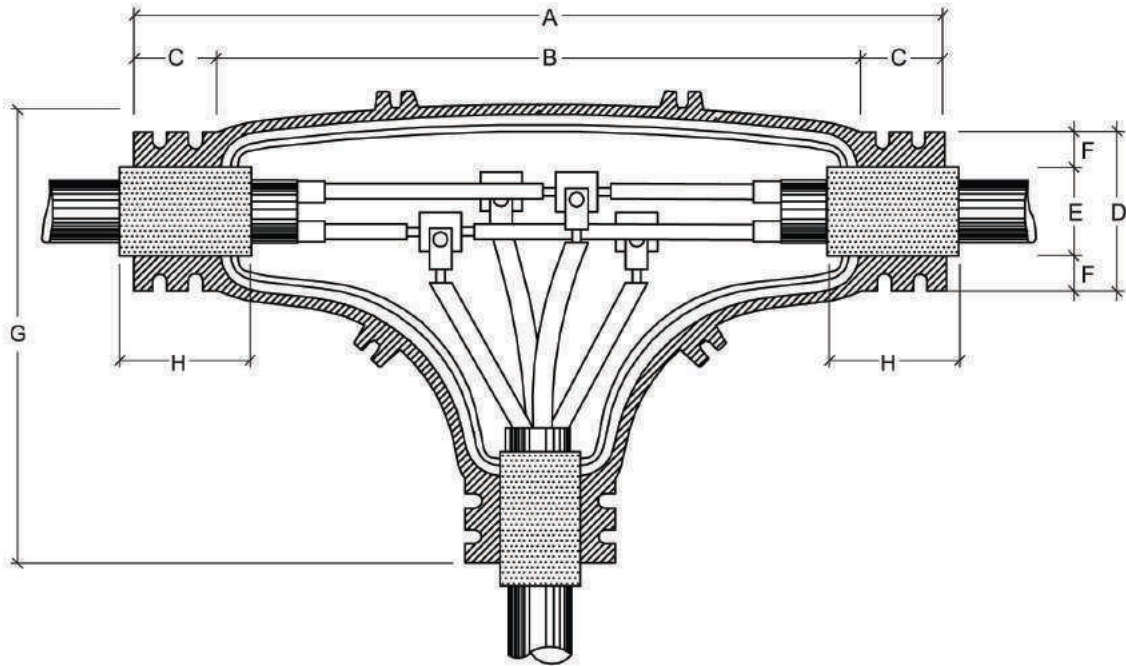

	KABLO mm <sup>2</sup>	A	B	C	D	E	F	G	BAND H	VIDA mm	YEDOFLEX
YM.2	10-16-25	324	220	52	71	31	20	210	50	M6	1400 gr
YM.3	35-50-70	324	220	52	71	31	20	210	50	M6	3750 gr
YM.4	95-120-150	544	400	72	103	55	24	349	90	M8	7500 gr
YM.5	185-240	664	500	82	118	70	24	427	100	M8	17500 gr

## DOLGU DÖKÜM MALZEMELERİ (PROTOLİN REÇİNE)



### TERMO-PLASTİK DOLGU MALZEMELERİ 1kV REÇİNE / PROTOLİN

KOD	ÜRÜN	FİYAT
10.005	100gr Ana Malzeme ve Sertleştirici	175,00 TL
10.022	250gr Ana Malzeme ve Sertleştirici	275,00 TL
10.004	300gr Ana Malzeme ve Sertleştirici	310,00 TL
10.003	500gr Ana Malzeme ve Sertleştirici	400,00 TL
10.001	1000gr Ana Malzeme ve Sertleştirici	750,00 TL
10.006	5000gr Ana Malzeme ve Sertleştirici	3,500,00 TL



### YEDOFLEX DOLGU MALZEMELERİ YENİDEN DOLDURULABİLİR / YEDO EKMUF

KOD	ÜRÜN	FİYAT
16.302	1250gr Ana Malzeme ve Sertleştirici	1,100,00 TL
16.303	1450gr Ana Malzeme ve Sertleştirici	1,200,00 TL
16.305	3500gr Ana Malzeme ve Sertleştirici	2,500,00 TL
16.306	3750gr Ana Malzeme ve Sertleştirici	2,600,00 TL
16.307	4250gr Ana Malzeme ve Sertleştirici	3,000,00 TL
16.308	5500gr Ana Malzeme ve Sertleştirici	3,500,00 TL

## AMBALAJ KÖPÜĞÜ



KOD	ÜRÜN	AĞIRLIK	ÖLÇÜSÜ	ŞİŞME KALINLIĞI	KOLİ AD.	FİYAT
14.001	NC-10	40 gr	24x15cm	14 cm	75	5,000 TL
14.002	NC-20	50 gr	25x18cm	8 cm	60	5,000 TL
14.003	NC-30	75 gr	25x25cm	7 cm	50	5,000 TL
14.004	NC-40	100 gr	25x45cm	7 cm	40	5,000 TL
14.005	NC-50	125 gr	40x40cm	7 cm	32	5,000 TL
14.006	NC-60	150 gr	45x45cm	10 cm	30	5,000 TL
14.007	NC-70	175 gr	50x50cm	10 cm	28	5,000 TL
14.008	NC-80	200 gr	60x50cm	10 cm	25	5,000 TL
14.009	NC-90	250 gr	65x65cm	10 cm	20	5,000 TL

## BAKIR İLETKENLİ ISI BÜZÜŞMELİ EKMUFLAR 1kV



### ISI BÜZÜŞMELİ EKMUFLAR 1kV STANDART TİP BAKIR KABLolar İÇİN

KOD	KESİT	FİYAT
12.002	4 x 2,5 mm <sup>2</sup>	275,00 TL.
12.003	4 x 4 mm <sup>2</sup>	275,00 TL.
12.004	4 x 6 mm <sup>2</sup>	275,00 TL.
12.005	4 x 10 mm <sup>2</sup>	350,00 TL.
12.006	4 x 16 mm <sup>2</sup>	375,00 TL.
12.007	3 x16 +10 mm <sup>2</sup>	375,00 TL.
12.008	3 x 25 +16 mm <sup>2</sup>	525,00 TL.
12.009	3 x 35 +16 mm <sup>2</sup>	575,00 TL.
12.010	3 x 50 +25 mm <sup>2</sup>	675,00 TL.
12.011	3 x 70 +35 mm <sup>2</sup>	975,00 TL.
12.012	3 x 95 +50 mm <sup>2</sup>	1,200,00 TL.
12.013	3 x 120 +70 mm <sup>2</sup>	1,550,00 TL.
12.014	3 x 150 +70 mm <sup>2</sup>	1,700,00 TL.
12.015	3 x 185 +95 mm <sup>2</sup>	2,500,00 TL.
12.016	3 x 240 +120 mm <sup>2</sup>	2,750,00 TL.

### ISI BÜZÜŞMELİ EKMUFLAR 1kV UZUN (BEDAŞ) TİP BAKIR KABLolar İÇİN

KOD	KESİT	BOY	FİYAT
12.201	4 x 6 mm <sup>2</sup>	30 cm	500,00 TL.
12.202	4 x 10 mm <sup>2</sup>	40 cm	550,00 TL.
12.203	4 x 16 mm <sup>2</sup>	50 cm	650,00 TL.
12.204	3 x16 +10 mm <sup>2</sup>	50 cm	850,00 TL.
12.205	3 x 25 +16 mm <sup>2</sup>	50 cm	850,00 TL.
12.206	3 x 35 +16 mm <sup>2</sup>	50 cm	950,00 TL.
12.207	3 x 50 +25 mm <sup>2</sup>	60 cm	1,150,00 TL.
12.208	3 x 70 +35 mm <sup>2</sup>	60 cm	1,550,00 TL.
12.209	3 x 95 +50 mm <sup>2</sup>	60 cm	1,850,00 TL.
12.210	3 x 120 +70 mm <sup>2</sup>	70 cm	2,150,00 TL.
12.211	3 x 150 +70 mm <sup>2</sup>	70 cm	2,400,00 TL.
12.212	3 x 185 +95 mm <sup>2</sup>	90 cm	3,500,00 TL.
12.213	3 x 240 +120 mm <sup>2</sup>	90 cm	3,750,00 TL.

## BAKIR KABLolar İÇİN ISI BÜZÜŞMELİ EK MUFLAR



### ÇELİK ZIRHLI BAKIR KABLolar İÇİN 1kV STANDART TİP

KOD	KESİT	FİYAT
12.101	4 x 2,5 mm <sup>2</sup>	425,00 TL.
12.102	4 x 4 mm <sup>2</sup>	425,00 TL.
12.103	4 x 6 mm <sup>2</sup>	425,00 TL.
12.104	4 x 10 mm <sup>2</sup>	625,00 TL.
12.105	4 x 16 mm <sup>2</sup>	650,00 TL.
12.105/A	3 x16 +10 mm <sup>2</sup>	650,00 TL.
12.106	3 x 25 +16 mm <sup>2</sup>	700,00 TL.
12.107	3 x 35 +16 mm <sup>2</sup>	750,00 TL.
12.108	3 x 50 +25 mm <sup>2</sup>	850,00 TL.
12.109	3 x 70 +35 mm <sup>2</sup>	1,150,00 TL.
12.110	3 x 95 +50 mm <sup>2</sup>	1,400,00 TL.
12.111	3 x 120 +70 mm <sup>2</sup>	1,800,00 TL.
12.112	3 x 150 +70 mm <sup>2</sup>	1,950,00 TL.
12.113	3 x 185 +95 mm <sup>2</sup>	2,850,00 TL.
12.114	3 x 240 +120 mm <sup>2</sup>	3,100,00 TL.

### ÇELİK ZIRHLI BAKIR KABLolar İÇİN 1kV UZUN (BEDAŞ) TİP

KOD	KESİT	BOY	FİYAT
12.301	4 x 6 mm <sup>2</sup>	30 cm	850,00 TL.
12.302	4 x 10 mm <sup>2</sup>	40 cm	900,00 TL.
12.303	4 x 16 mm <sup>2</sup>	50 cm	950,00 TL.
12.304	3 x16 +10 mm <sup>2</sup>	50 cm	950,00 TL.
12.305	3 x 25 +16 mm <sup>2</sup>	50 cm	1,200,00 TL.
12.306	3 x 35 +16 mm <sup>2</sup>	50 cm	1,300,00 TL.
12.307	3 x 50 +25 mm <sup>2</sup>	60 cm	1,550,00 TL.
12.308	3 x 70 +35 mm <sup>2</sup>	60 cm	1,950,00 TL.
12.309	3 x 95 +50 mm <sup>2</sup>	60 cm	2,100,00 TL.
12.310	3 x 120 +70 mm <sup>2</sup>	70 cm	2,600,00 TL.
12.311	3 x 150 +70 mm <sup>2</sup>	70 cm	2,850,00 TL.
12.312	3 x 185 +95 mm <sup>2</sup>	90 cm	4,000,00 TL.
12.313	3 x 240 +120 mm <sup>2</sup>	90 cm	4,250,00 TL.

## BAKIR İLETKENLİ ÖZEL TİP ISI BÜZÜŞMELİ EK MUFLAR



### ÖZEL ISI BÜZÜŞMELİ EK MUFLAR 1kV STANDART TİP BAKIR KABLolar İÇİN

KOD	KESİT	FİYAT
12.018	1 x 6 - 1 x 10 mm <sup>2</sup>	200,00 TL.
12.019	1 x 16 - 1 x 25 mm <sup>2</sup>	250,00 TL.
12.020	1 x 35 - 1 x 50 mm <sup>2</sup>	350,00 TL.
12.021	1 x 70 - 1 x 95 mm <sup>2</sup>	450,00 TL.
12.022	1 x 120 - 1 x 150 mm <sup>2</sup>	650,00 TL.
12.023	1 x 185 - 1 x 240 mm <sup>2</sup>	900,00 TL.
12.025	2 x 6 - 2 x 10 mm <sup>2</sup>	250,00 TL.
12.026	2 x 16 - 2 x 25 mm <sup>2</sup>	300,00 TL.
12.027	2 x 35 - 2 x 50 mm <sup>2</sup>	450,00 TL.
12.028	2 x 70 - 2 x 95 mm <sup>2</sup>	650,00 TL.
12.029	2 x 120 - 2 x 150 mm <sup>2</sup>	1,000,00 TL.
12.030	2 x 185 mm <sup>2</sup>	1,250,00 TL.
12.031	2 x 240 mm <sup>2</sup>	1,400,00 TL.
12.032	3 x 4 - 3 x 6 mm <sup>2</sup>	300,00 TL.
12.033	3 x 10 mm <sup>2</sup>	350,00 TL.
12.034	3 x 16 mm <sup>2</sup>	400,00 TL.
12.035	3 x 25 mm <sup>2</sup>	450,00 TL.
12.036	3 x 35 mm <sup>2</sup>	500,00 TL.
12.037	3 x 50 mm <sup>2</sup>	600,00 TL.
12.038	3 x 70 mm <sup>2</sup>	850,00 TL.
12.039	3 x 95 mm <sup>2</sup>	900,00 TL.
12.040	3 x 120 mm <sup>2</sup>	1,150,00 TL.
12.041	3 x 150 mm <sup>2</sup>	1,350,00 TL.
12.042	3 x 185 mm <sup>2</sup>	2,100,00 TL.
12.043	3 x 240 mm <sup>2</sup>	2,250,00 TL.

## ALÜMİNYUM İLETKENLİ ISI BÜZÜŞMELİ EK MUFLAR



### ISI BÜZÜŞMELİ EK MUFLAR 1kV STANDART TİP ALÜMİNYUM KABLolar İÇİN

KOD	KESİT	FİYAT
12.057	4 x 16 mm <sup>2</sup>	425,00 TL.
12.058	3 x 25 + 16 mm <sup>2</sup>	550,00 TL.
12.059	3 x 35 + 16 mm <sup>2</sup>	625,00 TL.
12.060	3 x 50 + 25 mm <sup>2</sup>	750,00 TL.
12.061	3 x 70 + 35 mm <sup>2</sup>	950,00 TL.
12.062	3 x 95 + 50 mm <sup>2</sup>	1,300,00 TL.
12.063	3 x 120 + 70 mm <sup>2</sup>	1,550,00 TL.
12.064	3 x 150 + 70 mm <sup>2</sup>	1,750,00 TL.
12.065	3 x 185 + 95 mm <sup>2</sup>	2,250,00 TL.
12.066	3 x 240 + 120 mm <sup>2</sup>	2,750,00 TL.

### ISI BÜZÜŞMELİ EK MUFLAR 1kV ÖZEL TİP ALÜMİNYUM KABLolar İÇİN

KOD	KESİT	FİYAT
12.069	1 x 16 - 1 x 25 mm <sup>2</sup>	250,00 TL.
12.070	1 x 35 - 1 x 50 mm <sup>2</sup>	350,00 TL.
12.071	1 x 70 - 1 x 95 mm <sup>2</sup>	450,00 TL.
12.072	1 x 120 - 1 x 150 mm <sup>2</sup>	650,00 TL.
12.073	1 x 185 - 1 x 240 mm <sup>2</sup>	900,00 TL.
12.074	2 x 16 - 2 x 25 mm <sup>2</sup>	300,00 TL.
12.075	2 x 35 - 2 x 50 mm <sup>2</sup>	450,00 TL.
12.076	2 x 70 - 2 x 95 mm <sup>2</sup>	650,00 TL.
12.077	2 x 120 mm <sup>2</sup>	900,00 TL.
12.078	2 x 150 mm <sup>2</sup>	1,000,00 TL.
12.079	2 x 185 mm <sup>2</sup>	1,250,00 TL.
12.080	2 x 240 mm <sup>2</sup>	1,400,00 TL.
12.081	3 x 16 mm <sup>2</sup>	400,00 TL.
12.082	3 x 25 mm <sup>2</sup>	450,00 TL.
12.083	3 x 35 mm <sup>2</sup>	500,00 TL.
12.084	3 x 50 mm <sup>2</sup>	600,00 TL.
12.085	3 x 70 mm <sup>2</sup>	850,00 TL.
12.086	3 x 95 mm <sup>2</sup>	900,00 TL.
12.087	3 x 120 mm <sup>2</sup>	1,150,00 TL.
12.088	3 x 150 mm <sup>2</sup>	1,350,00 TL.
12.089	3 x 185 mm <sup>2</sup>	2,100,00 TL.
12.090	3 x 240 mm <sup>2</sup>	2,250,00 TL.

## FERMUARLI BAKIR ISI BÜZÜŞMELİ KABLO EK MUFLARI



STOK KODU	KABLO KESİTİ	FİYAT
12.350	4 x 10 mm <sup>2</sup>	1,000,00 TL.
12.351	4 x 16 mm <sup>2</sup>	1,150,00 TL.
12.352	3 x 25 + 16 mm <sup>2</sup>	1,250,00 TL.
12.353	3 x 35 + 16 mm <sup>2</sup>	1,350,00 TL.
12.354	3 x 50 + 25 mm <sup>2</sup>	1,750,00 TL.
12.355	3 x 70 + 35 mm <sup>2</sup>	1,950,00 TL.
12.356	3 x 95 + 50 mm <sup>2</sup>	2,100,00 TL.
12.357	3 x 120 + 70 mm <sup>2</sup>	2,500,00 TL.
12.358	3 x 150 + 70 mm <sup>2</sup>	2,750,00 TL.
12.359	3 x 185 + 95 mm <sup>2</sup>	3,200,00 TL.
12.360	3 x 240 + 120 mm <sup>2</sup>	3,600,00 TL.
12.371	1 x 16 mm <sup>2</sup>	1,000,00 TL.
12.372	1 x 25 mm <sup>2</sup>	1,000,00 TL.
12.373	1 x 35 mm <sup>2</sup>	1,100,00 TL.
12.374	1 x 50 mm <sup>2</sup>	1,100,00 TL.
12.375	1 x 70 mm <sup>2</sup>	1,200,00 TL.
12.376	1 x 95 mm <sup>2</sup>	1,200,00 TL.
12.377	1 x 120 mm <sup>2</sup>	1,300,00 TL.
12.378	1 x 150 mm <sup>2</sup>	1,300,00 TL.
12.379	1 x 185 mm <sup>2</sup>	1,450,00 TL.
12 380	1 x 240 mm <sup>2</sup>	1,450,00 TL.

## FERMUARLI ALÜMİNYUM ISI BÜZÜŞMELİ KABLO EK MUFLARI



STOK KODU	KABLO KESİTİ	FİYAT
12.381	4 x 16 mm <sup>2</sup>	1,150,00 TL.
12.382	3 x 25 + 16 mm <sup>2</sup>	1,250,00 TL.
12.383	3 x 35 + 16 mm <sup>2</sup>	1,350,00 TL.
12.384	3 x 50 + 25 mm <sup>2</sup>	1,750,00 TL.
12.385	3 x 70 + 35 mm <sup>2</sup>	1,950,00 TL.
12.386	3 x 95 + 50 mm <sup>2</sup>	2,100,00 TL.
12.387	3 x 120 + 70 mm <sup>2</sup>	2,500,00 TL.
12.388	3 x 150 + 70 mm <sup>2</sup>	2,750,00 TL.
12.389	3 x 185 + 95 mm <sup>2</sup>	3,200,00 TL.
12.390	3 x 240 + 120 mm <sup>2</sup>	3,600,00 TL.
12.391	1 x 16 mm <sup>2</sup>	1,000,00 TL.
12.392	1 x 25 mm <sup>2</sup>	1,000,00 TL.
12.393	1 x 35 mm <sup>2</sup>	1,100,00 TL.
12.394	1 x 50 mm <sup>2</sup>	1,100,00 TL.
12.395	1 x 70 mm <sup>2</sup>	1,200,00 TL.
12.396	1 x 95 mm <sup>2</sup>	1,200,00 TL.
12.397	1 x 120 mm <sup>2</sup>	1,300,00 TL.
12.398	1 x 150 mm <sup>2</sup>	1,300,00 TL.
12.390	1 x 185 mm <sup>2</sup>	1,450,00 TL.
12.400	1 x 240 mm <sup>2</sup>	1,450,00 TL.

# FERMUARLI ISI BÜZÜŞMELİ KABLO YAMASI

## Fermuarlı Isı Büzüşmeli Makaron Kablo Yaması



**0,6-1kV**

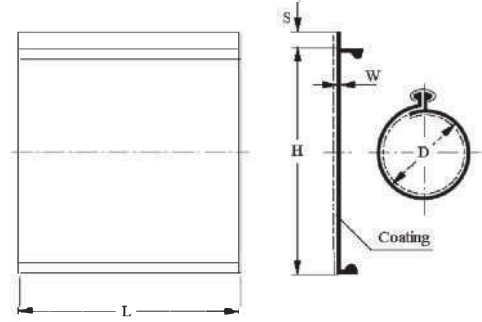

ÜRÜN KODU	KABLO KESİTİ	KABLO ÇAPI ARALIĞI (mm)"	DARALMADAN ÖNCE (mm)	DARALMADAN SONRA (mm)	DARALMADAN SONRA ET KAL. (mm)	BOY (L) (MT.)	USD Ad
12.451- 30/12	4x2,5 4x4 - 4x6 - 4x10	13-22	30	12	3,8	1	<b>58,00 \$</b>
12.452- 40/12	3x25+16 / 3x35+16 4x16	23-33	40	18	3,8	1	<b>60,00 \$</b>
12.453- 50/17	3x50+25 3x70 + 35	31-43	50	18	3,8	1	<b>65,00 \$</b>
12.454- 65/24	3x95+50 3x120+70	35-52	65	22	3,8	1	<b>70,00 \$</b>
12.455- 85/27	3x150+70 3x185 + 95	57-73	85	35	3,8	1	<b>80,00 \$</b>
12.456- 100/27	3x240+120 3x300+150	76	100	35	3,8	1	<b>90,00 \$</b>

### Teknik Özellikler

Su Emme: 0,1%

Daralma Oranı: 3/1

Renk: Siyah, İçi Yapışkanlı,  
Çalışma Sıcaklığı  
-450°C +1050°C

\*Fermuarlı Isıyla Daralan tamir borusu, enerji kablolarında hızlı ve kalıcı izolasyon, sızdırmazlık ve mekanik koruma sağlamak amacıyla geliştirilmiştir. Poliolefin dış kaplama ve iç yüzeyinde sıcak eriyen yapıştırıcı ile üstün performans sağlar.

Fiyatlarımıza KDV Dahil Değildir.

## KABLO BAĞLANTI ELEMANLARI



### BAKIR BORU MUF

KOD	KESİT	KUTU AD.	FİYAT
21.001	2,5 mm	1000	17,50 TL.
21.002	4-6 mm	500	17,50 TL.
21.003	10 mm	500	19,00 TL.
21.004	16 mm	500	20,00 TL.
21.005	25 mm	250	32,50 TL.
21.006	35 mm	200	45,00 TL.
21.007	50 mm	150	57,50 TL.
21.008	70 mm	100	95,00 TL.
21.009	95 mm	75	115,00 TL.
21.010	120 mm	50	155,00 TL.
21.011	150 mm	40	235,00 TL.
21.012	185 mm	30	285,00 TL.
21.013	240 mm	25	435,00 TL.



### U KLEMENS

KOD	KESİT	KUTU AD.	FİYAT
21.301	6 mm	300	55,00 TL.
21.302	10 mm	250	70,00 TL.
21.303	16 mm	100	105,00 TL.
21.304	25 mm	100	125,00 TL.
21.305	35 mm	75	145,00 TL.
21.306	50 mm	50	225,00 TL.
21.307	70 mm	40	280,00 TL.
21.308	95 mm	25	410,00 TL.
21.309	120 mm	20	535,00 TL.
21.310	150 mm	15	710,00 TL.



### PİRİNÇ KANCA SERFİL

KOD	KESİT	KUTU AD.	FİYAT
21.201	16 mm	350	155,00 TL.
21.202	25 mm	300	175,00 TL.
21.203	35 mm	300	190,00 TL.
21.204	50 mm	250	205,00 TL.
21.205	70 mm	200	285,00 TL.
21.206	95 mm	175	310,00 TL.
21.207	120 mm	150	340,00 TL.
21.208	150 mm	100	410,00 TL.
21.209	185 mm	75	530,00 TL.
21.210	240 mm	60	700,00 TL.

## BAKIR KABLO PABUÇLARI



### BAKIR SKP (KABLO PABUCU) STANDART

KOD	KESİT	D. ÇAP	KUTU AD.	FİYAT
21.100	6 mm	M5	500	19,00 TL.
21.101	10 mm	M5	500	19,00 TL.
21.102	16 mm	M6	500	27,50 TL.
21.103	25 mm	M8	250	45,00 TL.
21.104	35 mm	M8	200	64,00 TL.
21.105	50 mm	M10	150	92,50 TL.
21.106	70 mm	M10	100	120,00 TL.
21.107	95 mm	M12	75	158,00 TL.
21.108	120 mm	M12	50	225,00 TL.
21.109	150 mm	M12	40	340,00 TL.
21.110	185 mm	M16	30	398,00 TL.
21.111	240 mm	M16	25	540,00 TL.

### BAKIR SKP (KABLO PABUCU) EKO 1

KOD	KESİT	D. ÇAP	KUTU AD.	FİYAT
21.122	16 mm	M6	500	18,50 TL.
21.112	16 mm	M8	500	20,00 TL.
21.123	25 mm	M8	350	30,00 TL.
21.124	35 mm	M8	250	42,00 TL.
21.125	50 mm	M10	150	53,00 TL.
21.126	70 mm	M10	100	92,50 TL.
21.127	95 mm	M12	75	105,00 TL.
21.128	120 mm	M12	50	145,00 TL.
21.129	150 mm	M12	40	200,00 TL.
21.130	185 mm	M16	30	268,00 TL.
21.131	240 mm	M16	25	415,00 TL.

## ALÜMİNYUM KABLO MUFLARI



### ALÜMİNYUM BORU MUF

KOD	KESİT	KUTU AD.	FİYAT
21.017	16 mm	450	24,00 TL.
21.018	25 mm	250	27,50 TL.
21.019	35 mm	150	37,50 TL.
21.020	50 mm	150	46,50 TL.
21.021	70 mm	100	65,00 TL.
21.022	95 mm	75	90,00 TL.
21.023	120 mm	75	105,00 TL.
21.024	150 mm	50	130,00 TL.
21.025	185 mm	40	165,00 TL.
21.026	240 mm	30	238,00 TL.

### ALÜMİNYUM SKP



KOD	KESİT	D. ÇAP	KUTU AD.	FİYAT
21.161	16 mm	M6	450	24,00 TL.
21.162	25 mm	M8	250	27,50 TL.
21.163	35 mm	M8	150	37,50 TL.
21.164	50 mm	M10	150	46,50 TL.
21.165	70 mm	M12	100	65,00 TL.
21.166	95 mm	M12	75	90,00 TL.
21.167	120 mm	M12	75	105,00 TL.
21.168	150 mm	M12	50	130,00 TL.
21.169	185 mm	M12	40	165,00 TL.
21.170	240 mm	M12	30	238,00 TL.

### Bİ-METAL SKP

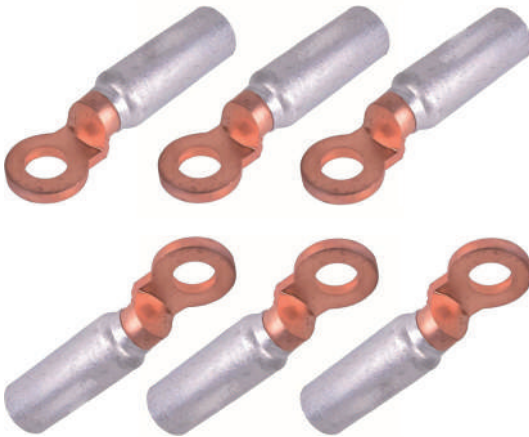

KOD	KESİT	Bİ-METAL	KUTU AD.	FİYAT
21.422	16 mm	Bİ-METAL	100	145,00 TL.
21.423	25 mm	Bİ-METAL	100	145,00 TL.
21.424	35 mm	Bİ-METAL	100	145,00 TL.
21.425	50 mm	Bİ-METAL	50	195,00 TL.
21.426	70 mm	Bİ-METAL	50	195,00 TL.
21.427	95 mm	Bİ-METAL	50	195,00 TL.
21.428	120 mm	Bİ-METAL	24	325,00 TL.
21.429	150 mm	Bİ-METAL	24	325,00 TL.
21.430	185 mm	Bİ-METAL	12	525,00 TL.
21.431	240 mm	Bİ-METAL	12	525,00 TL.

## OTOMASYON



### TRİFAZE BARA

KOD			KUTU AD.	FİYAT
25.111	53 cm 0,80mm	63A 10 Modül	25	625,00 TL.
25.112	106 cm 0,80mm	63A 20 Modül	25	1,250,00 TL.
25.101	53 cm 1mm	80A 10 Modül	25	775,00 TL.
25.102	106 cm 1mm	80A 20 Modül	25	1,550,00 TL.
25.110	Trifaze Yan Kapak		1000	10,50 TL.



### MONOFAZE BARA

KOD			KUTU AD.	FİYAT
25.001	53 cm 1 mm	80A 30 Modül	50	300,00 TL.
25.002	106 cm 1 mm	80A 60 Modül	50	600,00 TL.
25.005	53 cm 0,80mm	63A 30 Modül	50	250,00 TL.
25.006	106 cm 0,80mm	63A 60 Modül	50	500,00 TL.



### TOPRAKLAMA BARASI

KOD			KUTU AD.	FİYAT
25.201	1,5 mm	31 Vida	40	875,00 TL.
25.202	1,5 mm	61 Vida	40	1,075,00 TL.
25.203	2 mm	31 Vida	40	1,125,00 TL.
25.204	2 mm	61 Vida	40	1,375,00 TL.



### W OTOMAT RAYI (DÜZ)

KOD		KUTU AD.	FİYAT
25.401	1 Metre	50	87,50 TL.
25.402	2 Metre	25	175,00 TL.



# Registration Certificate

This is to certify that  
The Quality Management Systems  
Of

## KETENCİ SANAYİ VE TİCARET KOLLEKTİF ŞİRKETİ ERDAL KILIÇ VE ORTAĞI

Carried out at following site:

Fabrika: Orta Mahallesi Topkapı Maltepe Caddesi No: 28-30/6 Bayrampaşa  
İSTANBUL/Türkiye

&  
Merkez: Bankalar Caddesi, Emekyemez Mahallesi, Tutsak Sokak, Sarıoğlu Han No:10  
80020 Karaköy İSTANBUL/Türkiye

Has been found to conform to the Quality Management System Standard:

## ISO 9001:2015

This certificate is valid for the following Product or Service ranges:

Design, Manufacture and Sales of Switch, Isolator, Cable Caps, Termo-Plastic and Refillable Filling Material, Cable Joint, Refillable Plastic Cable Joints, Socket and Socket Box.  
(Şalter, İzolatör, Kablo Başlıkları, Termo Plastik ve Yeniden Doldurulabilir Dolgu Malzemesi, Ek Muf, Yeniden Doldurulabilir Plastik Ek Mufları, Priz ve Priz Kutusu Tasarımı, Üretimi ve Satışı.)  
IAF CODE – 14, 19 & 29

CERTIFICATE NO. : CCPL/QMS/C1275

ISSUED ON : 16/07/2025

1<sup>ST</sup> SURVEILLANCE DUE ON: 16/06/2026

VALIDITY DATE : 15/07/2028

2<sup>ND</sup> SURVEILLANCE DUE ON: 16/06/2027

THE VALIDITY OF CERTIFICATE IS SUBJECT TO REGULAR SURVEILLANCE AUDIT ON OR BEFORE ABOVE MENTIONED DATES AND IT'S ONLY VALID AFTER SUCCESSFUL SURVEILLANCE WITH CONTINUATION LETTER ISSUED BY CCPL

TO VERIFY THE STATUS OF THE CERTIFICATE, PLEASE VISIT IAF SEARCH CERT WEBSITE <https://www.iafcertsearch.org/>



  
CHAIRMAN

Care Certification Private Limited

134A, 2nd Floor, Taimoor Nagar,  
New Friends Colony, New Delhi-110065 (India)  
[www.carecertification.com](http://www.carecertification.com)



# Registration Certificate

This is to certify that  
The Management Systems of

**KETENCİ SANAYİ VE TİCARET KOLLEKTİF  
ŞİRKETİ ERDAL KILIÇ VE ORTAĞI**

Carried out at following site:

**Fabrika: Orta Mahallesi Topkapı Maltepe Caddesi No: 28-30/6 Bayrampaşa  
İSTANBUL/Türkiye**

&

**Merkez: Bankalar Caddesi, Emekyemez Mahallesi, Tutsak Sokak, Sarıoğlu Han No:10  
80020 Karaköy İSTANBUL/Türkiye**

Has been found to conform to the environmental management system Standard:

## ISO 14001:2015

This certificate is valid for the following Product or Service ranges:

**Design, Manufacture and Sales of Switch, Isolator, Cable Caps, Termo-Plastic and Refillable  
Filling Material, Cable Joint, Refillable Plastic Cable Joints, Socket and Socket Box.  
(Şalter, İzolatör, Kablo Başlıkları, Termo Plastik ve Yeniden Doldurulabilir Dolgu  
Malzemesi, Ek Muf, Yeniden Doldurulabilir Plastik Ek Mufları, Priz ve Priz Kutusu  
Tasarımı, Üretimi ve Satışı.)  
IAF CODE – 14, 19 & 29**

CERTIFICATE NO. : CCPL/EMS/C1067

ISSUED ON : 16/07/2025

1<sup>ST</sup> SURVEILLANCE DUE ON: 16/06/2026

VALIDITY DATE : 15/07/2028

2<sup>ND</sup> SURVEILLANCE DUE ON: 16/06/2027

THE VALIDITY OF CERTIFICATE IS SUBJECT TO REGULAR SURVEILLANCE AUDIT ON OR  
BEFORE ABOVE MENTIONED DATES AND IT'S ONLY VALID AFTER SUCCESSFUL  
SURVEILLANCE WITH CONTINUATION LETTER ISSUED BY CCPL

TO VERIFY THE STATUS OF THE CERTIFICATE, PLEASE VISIT IAF SEARCH CERT WEBSITE <https://www.iafcertsearch.org/>



*[Signature]*  
CHAIRMAN

**Care Certification Private Limited**

134A, 2nd Floor, Taimoor Nagar,  
New Friends Colony, New Delhi-110065 (India)  
[www.carecertification.com](http://www.carecertification.com)



Merkez : Bankalar Cad. Emekyemez Mah. Okçumusa Cad. Tutsak Sk. Sarıoğlu İş Hanı No:10 D:3 34421 Karaköy/İST.  
 Tel: 0 212 237 70 02 Gsm: 0533 326 45 25  
 info@ketenci.com.tr \* www.ketenci.com.tr